



CELEBRATING 25 YEARS!

Custom Cabinetry
Countertops
Custom Finishing
Prefinished Hardwood
Flooring
Prefinished Shiplap
Tongue & Groove

About Us

SWI Interiors is a privately owned custom cabinet manufacturer. Founded in 1996, SWI Interiors started out as a one man shop building modest kitchen and bath cabinetry from a barn in the small rural town of Osage, Minnesota. Over 25 years later, Steve, along with his wife Heidi have developed the once small shop into a state-of-the-art, 65,000 square foot facility equipped with CNC machining, flat line finishing, and design center with the latest in custom cabinetry software.



SWI offers custom built cabinetry, laminate & solid surface countertops, closet systems, pre-finished hardwood flooring, tongue & groove paneling, millwork/case work and custom finishing of millwork. Custom cabinetry is our specialty, offering a large variety of woods, door styles, stain and paint colors, 1/2" dovetail drawers, and virtually unlimited customization for our customers. We can produce a small vanity or an entire house. No project is too big or small!

Our primary objective is to provide a quality product and outstanding customer service. We take great pride in producing a custom product and enjoy seeing it take shape and become that focal point your home.

Cabinet Specifications

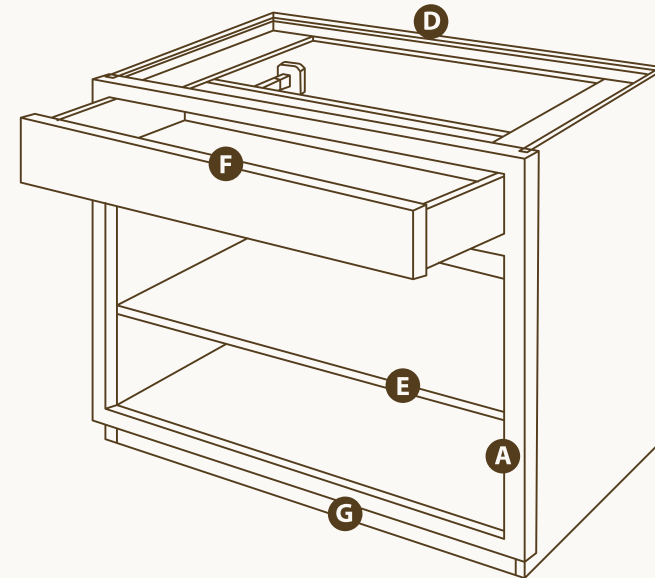
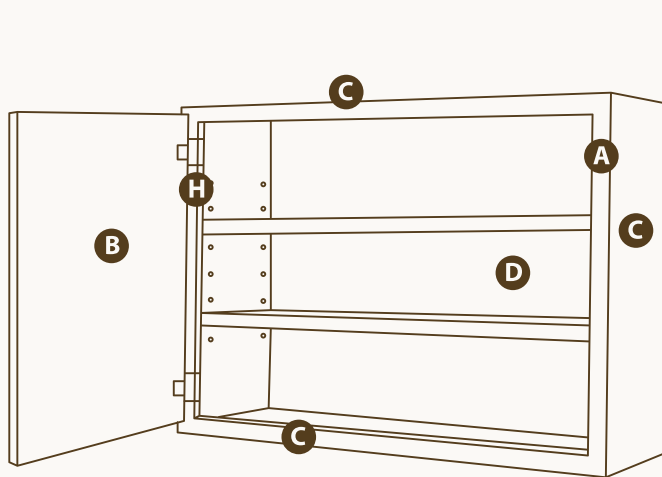

A. Face Frames

- Constructed of $\frac{3}{4}$ " solid wood
- All face frames are precisely aligned with glue and nailed for reinforcement

B. Doors

- Solid wood stile and rails
- Solid wood, wood veneer or various hardwood component door panels

C. Top, Bottom, and End Panels

- Constructed of $\frac{3}{4}$ " particleboard with $\frac{3}{4}$ " Hard Rock Maple interiors

D. Back Panels

- Constructed of $\frac{1}{2}$ " Hard Rock Maple

E. Shelves

- $\frac{3}{4}$ " thick full depth adjustable edge banded Hard Rock Maple

F. Drawers

- Constructed of $\frac{1}{2}$ " Birch plywood dovetailed drawer box with a $\frac{1}{4}$ " Birch plywood bottom
- $\frac{7}{8}$ " extension undermount soft close drawer sides w/ a 150 lb load rating

G. Toe Kick

- The toe kick is inset into the cabinet box $3\frac{3}{4}$ " and is $3\frac{3}{4}$ " high
- Toe Kicks are $\frac{3}{4}$ " particleboard

H. Hinges

- Standard Overlay - Compact 38 concealed 105° soft close cup hinge
- Full Overlay - Compact 39 concealed 110° soft close cup hinge

Wood Species, Door Style & Color Options

Red Oak

Is characterized by its wide-open grain patterns & extreme durability. Variation in grain pattern & color, small knots & pin holes are attributes of nature giving oak its distinctive beauty. Natural occurring color variation includes light tan & pink to medium dark red & brown with occasional green, yellow & black mineral streaks. These characteristics are more prominent in natural & lighter stain finishes.

Birch

Birch has light yellow sapwood and reddish-brown heartwood. Once stained, the color differences are less pronounced. It has straight, close grain and a fine, even texture.

Hickory

Is known for its strength, open grain & distinctive color variation within each piece of wood. Ranging from light to deep brown, hickory's unpredictable color spread is especially noticeable in a natural or light finish, with darker stains mellowing the variation. Color variation, small pin holes & knots are naturally occurring & rustic hickory incorporates larger sporadic knots & pin holes. These characteristics are acceptable & not considered warranty defects.

Alder

Has a fine, straight-grain pattern & even texture. The color is a light brown with a reddish tinge that stains evenly. Alder includes character spots, knots, burls & blemishes which do not affect product durability. As one of the softest hardwoods, alder can be easily dented or scratched. These characteristics are not considered warranty defects.

Painted MDF/HDF

Combines hardwoods & engineered materials including solid wood, engineered materials – such as medium density fiberboard (MDF) & high-density fiberboard (HDF) & similar composite materials providing a smoother surface for painting & superior stability, consistency & durability.

Montana Maple

Montana Maple is very similar to hard maple in most respects. Generally, the sapwood is greyish-white, sometimes with darker colored pith flecks. The heartwood varies from light to dark reddish-brown. The wood is usually straight-grained.

Other wood species available upon request:

Cherry, Rustic Cherry, Maple, Rustic Maple, Soft Maple, Walnut, Quarter Sawn White Oak, Circle Sawn Rustic Hickory and more.

Wood Species, Door Style & Color Options

Rustic

The term rustic refers to using material that presents a more authentic country, rural feel to the cabinetry. The cabinets are designed to include a large amount of character elements in the wood. These elements include:

- **Knots** – solid, with no loose material
- **Heartwood & Sapwood** – heartwood is the center part of the log. It is usually darker than the surrounding sapwood which is considered the “living” part of the tree. This is especially true with hickory where the contrast can be dramatic.
- **Pitch pockets** – these are openings in the sapwood where sap has accumulated.
- **Checks & splits** – these are cracks in the wood where the wood cells have split.
- **Mineral streaks** – form when trees absorb minerals from the soil & stain the wood fiber.

The Rustic cabinetry you buy can have some or all these elements. They are distributed randomly by nature. This gives the cabinetry its rustic appeal.

The Rule of 3

Having the entire cabinet be made of rustic material would be too much & overpower the room. Cabinets that have rustic parts are specified to have approximately 1/3 knots, 1/3 rustic characteristics other than knots & 1/3 clear. This has proven to be the most aesthetically appealing ratio.

It is possible that a random door or drawer front will not have a knot or characteristic. This is by design for a better visual appearance & not considered a quality defect.

All Door styles are available in Standard, Full Overlay and Frameless.

Soft Close Door and Undermount Soft Close Drawer come standard in all Dynamic Homes Cabinetry.

Alder/Rustic Alder

Color Options

What Color Inspires You?

Choosing the right color and style can bring your cabinetry to life. If one of the standard stain or paint options available speaks to you great. If its not, there are other colors available to choose that is perfect for your project by doing a custom paint or stain color. For a custom color match we will provide you with a sample for approval. This may increase your delivery time.

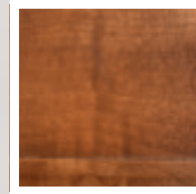

Burnt Sugar

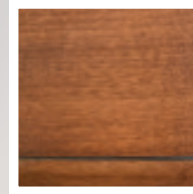

*Burnt Sugar
Black Glaze*

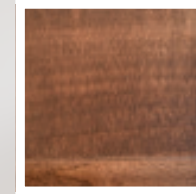

Chatham

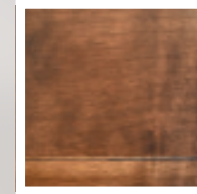

Dark Mocha

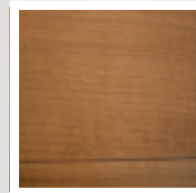

Fruitwood

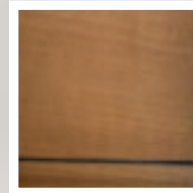

*Fruitwood
Black Glaze*

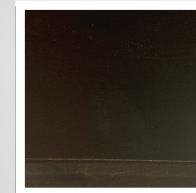

*Greywash
Peppercorn*

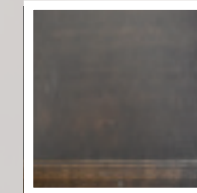

Hazelnut

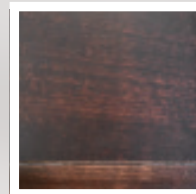

Molasses

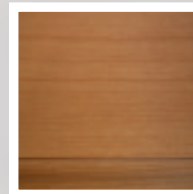

Natural

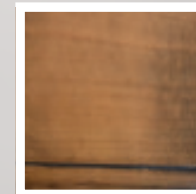

*Natural
Black Glaze*

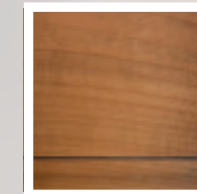

*Natural
Chocolate Glaze*

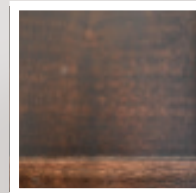

Russet

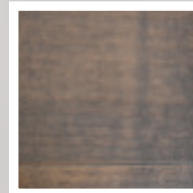

Silver Fox

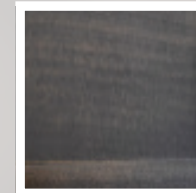

Taconite

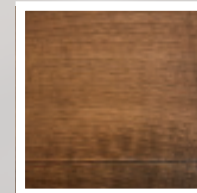

Windsor

Birch



Burnt Sugar



*Burnt Sugar
Black Glaze*



Chatham



Dark Mocha

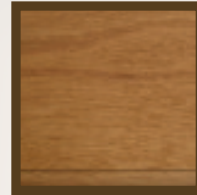

Fruitwood



*Fruitwood
Black Glaze*



*Greywash
Peppercorn*

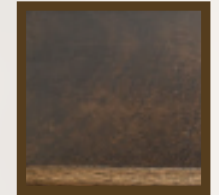

Hazelnut



Molasses

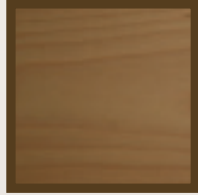

Natural

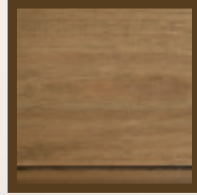

*Natural
Black Glaze*

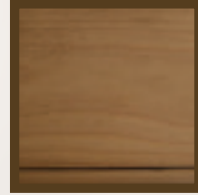

*Natural
Chocolate Glaze*

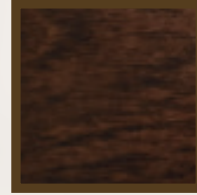

Russet



Silver Fox



Taconite



Windsor

Red Oak

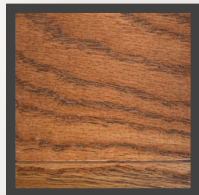

Burnt Sugar

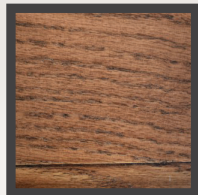

Chatham

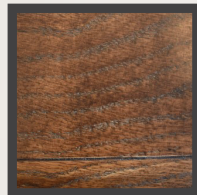

Dark Mocha

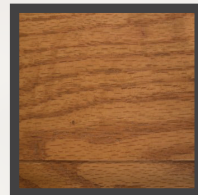

Fruitwood

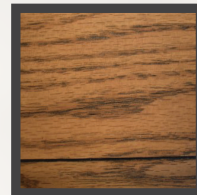

*Fruitwood
Black Glaze*



*Greywash
Peppercorn*

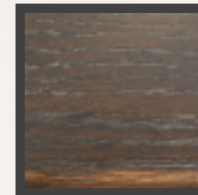

Hazelnut

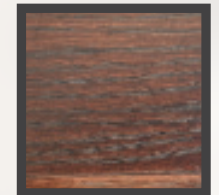

Molasses

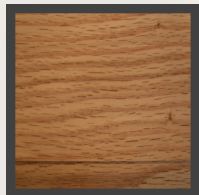

Natural

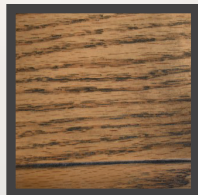

*Natural
Black Glaze*



*Natural
Chocolate Glaze*

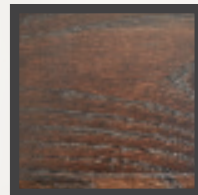

Russet

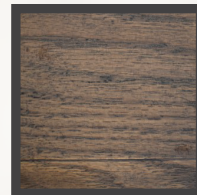

Silver Fox

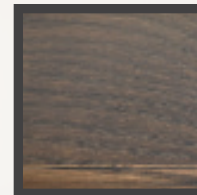

Taconite

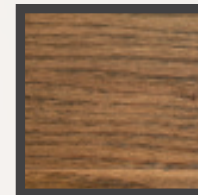

Windsor

Hickory/Rustic Hickory



Burnt Sugar



*Burnt Sugar
Black Glaze*



Chatham

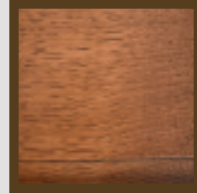

Dark Mocha

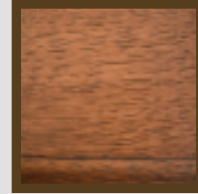

*Dark Mocha
Black Glaze*

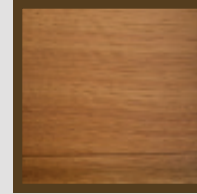

Fruitwood

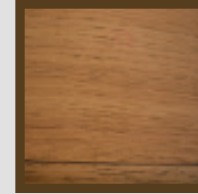

*Fruitwood
Black Glaze*



*Greywash
Peppercorn*



Hazelnut



Molasses

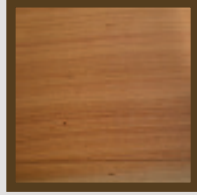

Natural

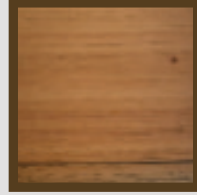

*Natural
Black Glaze*

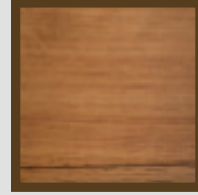

*Natural
Chocolate Glaze*

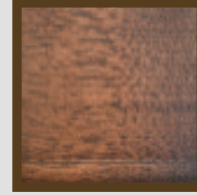

Russet

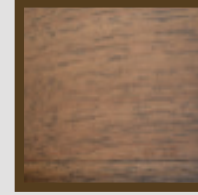

Silver Fox

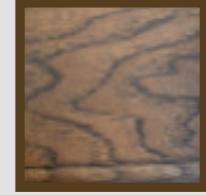

Taconite



Windsor



MDF/HDF - Painted

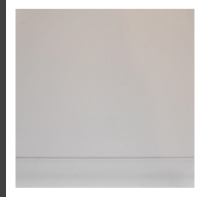

Pro White



*Pro White
Black Glaze*

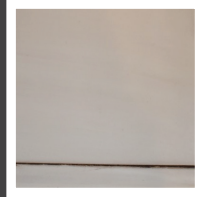

*Pro White
Chocolate Glaze*

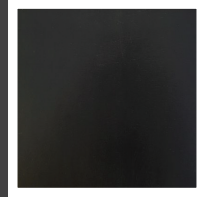

Black



*Black
White Powder Glaze*

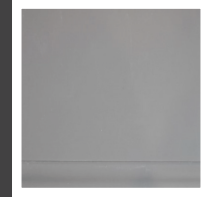

*Gauntlet
Grey*



Black Fox



Creamy



*Creamy
Black Glaze*



*Creamy
Chocolate Glaze*

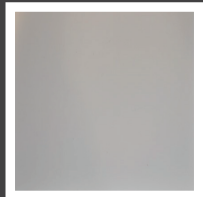

Accessible Beige



*Accessible Beige
Black Glaze*

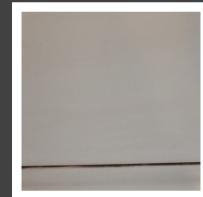

*Accessible Beige
Chocolate Glaze*

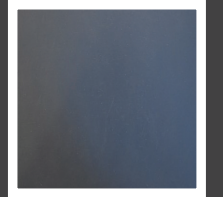

Naval

Drawer Front Options

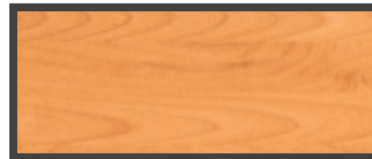

Flat Drawer Front

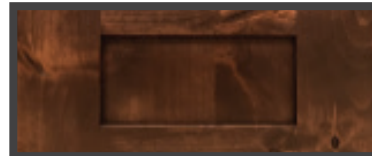

5 Piece Drawer Front

**Available with Big Sky,
Hendrick, Midwest, Lewis &
Julia Door Style*



Specialty Wood Species Options



Circle Sawn Rustic Hickory
Natural with Black Glaze



Montana
Maple



Door Styles



Big Sky

Shown In: Burnt Sugar on Red Oak
1/4" Flat Panel with 3" Stile & Rails

Overlay: Standard or Full

Drawer Front: Flat or 5 Piece

Offered In: Red Oak, Hickory, Rustic Hickory, Alder, Rustic Alder, Birch, Knotty Pine



Craftsmen

Shown In: Burnt Sugar on Alder
1/4" Flat Panel with 2 1/4" Stile & Rails

Overlay: Standard or Full

Drawer Front: Flat

Offered In: Red Oak, Hickory, Rustic Hickory, Alder, Rustic Alder, Birch, Knotty Pine

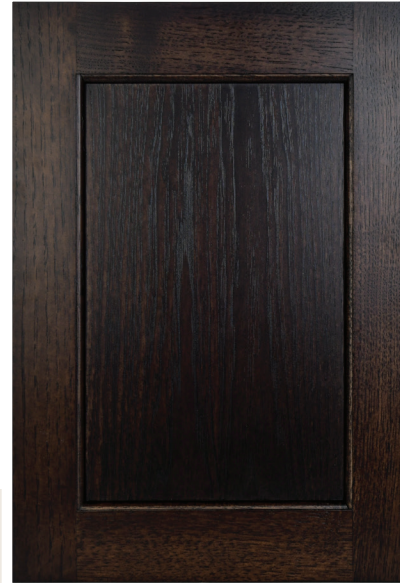

Emmons

Shown In: Russet on Hickory
1/4" Flat Panel with 2 1/4" Stile & Rails

Overlay: Standard or Full

Drawer Front: Flat

Offered In: Red Oak, Hickory, Rustic Hickory, Alder, Rustic Alder, Birch, Knotty Pine



Hendrick

Shown In: Silver Fox on Rustic Alder
1/4" Flat Panel with 3" Stile & Rails

Overlay: Standard or Full

Drawer Front: Flat or 5 Piece

Offered In: Red Oak, Hickory, Rustic Hickory, Alder, Rustic Alder, Birch, Knotty Pine

Door Styles



Jade

Shown In: Chatham on Hickory
1/4" Flat Panel with 2 1/4" Stile & Rails

Overlay: Standard or Full

Drawer Front: Flat

Offered In: Red Oak, Hickory, Rustic Hickory, Alder, Rustic Alder, Birch, Knotty Pine



Midwest

Shown In: Fruitwood on Rustic Alder
1/4" Flat Panel with 2 1/4" Stile & Rails

Overlay: Standard or Full

Drawer Front: Flat or 5 Piece

Offered In: Red Oak, Hickory, Rustic Hickory, Alder, Rustic Alder, Birch, Knotty Pine



Cottage

Shown In: Natural on Rustic Alder
1/4" Beaded Panel with
2 1/4" Stile & Rails

Overlay: Standard or Full

Drawer Front: Flat

Offered In: Red Oak, Alder, Rustic Alder



Cape Town

Shown In: Dark Mocha on Alder
3/4" Solid Wood Reversed Raised
Panel with 2 1/4" Stile & Rails

Overlay: Standard or Full

Drawer Front: Flat

Offered In: Red Oak, Hickory, Rustic Hickory, Alder, Rustic Alder, Birch, Knotty Pine

Door Styles



Lewis

Shown In: Molasses on Rustic Hickory
3/4" Solid Wood Raised Panel with 3"
Stile & Rails

Overlay: Standard or Full

Drawer Front: Flat or 5 Piece

Offered In: Red Oak, Hickory, Rustic
Hickory, Alder, Rustic Alder, Birch,
Knotty Pine



Baxter

Shown In: Hazelnut on Alder
3/4" Solid Wood Raised Panel with
2 1/4" Stile & Rails

Overlay: Standard or Full

Drawer Front: Flat

Offered In: Red Oak, Hickory, Rustic
Hickory, Alder, Rustic Alder, Birch,
Knotty Pine



Ray

Shown In: Taconite on Rustic Hickory
3/4" Solid Wood Reversed Raised
Backwards Panel with
2 1/4" Stile & Rails

Overlay: Standard or Full

Drawer Front: Flat

Offered In: Red Oak, Hickory, Rustic
Hickory, Alder, Rustic Alder, Birch,
Knotty Pine



Claire

Shown In: Pro White
Flat Panel with 2 1/4" Stile & Rails

Overlay: Standard or Full

Drawer Front: Flat

Offered In: MDF/HDF

Door Styles



Julia

Shown In: Naval
Flat with 3" Stile & Rails

Overlay: Standard or Full

Drawer Front: Flat or 5 Piece

Offered In: MDF/HDF



Dalton

Shown In: Creamy
Flat Panel with 2 1/4" Stile & Rails

Overlay: Standard or Full

Drawer Front: Flat

Offered In: MDF/HDF



Osage

Shown In: Gauntlet Grey
Raised Panel with 2 1/4" Stile & Rails

Overlay: Standard or Full

Drawer Front: Flat

Offered In: MDF/HDF



Glazing & Distressing



*Silver Fox with
Chocolate Glaze
on Rustic Alder*



*Taconite with
White Powder Glaze
on Rustic Hickory*



*Burnt Sugar with
Black Glaze and Oversanded
on Alder*



*Pro White with Black Glaze,
Oversanded and Distressed
on MDF*



This kitchen is pictured in Natural Rustic Hickory with a Black Glaze and Distressed.

Glazed finishes highlight detail and create an impression of aging. Glazing is a finish step in which a pigmented material is applied to the surfaces, then hand-wiped partially away. This allows the glazing to “hangup” in areas of detail. Since this process is done by hand no two doors will look exactly alike.

Distressing provides an aged, timeworn look to cabinetry. SWI Interiors distressing includes your choice of oversanding and/or distressing.

Hardware Styles

Alesund



BWP 2280 OBH



BWP 2283 OBH



BWP 2280 SN



BWP 2283 SN

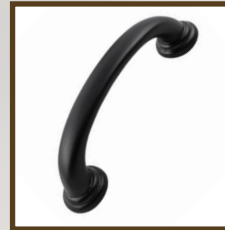

BWP 2280 MB



BWP 2283 MB

Aspire



BE 2029 10VB



BE 2033 10VB



BE 9232 10BT



BE 9244 10BT



BE 2136 1055



BE 2141 1055

Canal



A53013 ORB

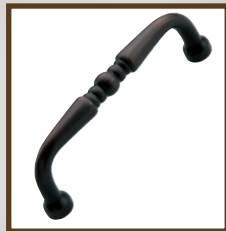

A53006 ORB



A53005 ORB



A53013 G10



A53006 G10



A53005 G10



A53013 FB



A53006 FB



A53005 FB

Contemporary Round



BE 9114 10VB



BE 9338 10VB



BE 9120 1BPN



BE 9432 4BPN



BE 9118 1055



BE 9132 1055

Contemporary Square



BE 9029 40VB



BE 0953 10VB



BE 9009 4BPN



BE 0949 1BPN



BE 9011 4005



BE 0951 1055

Hearthstone



BE 4063 10VB

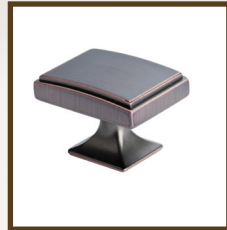

BE 4081 10VB



BE 4064 1BPN



BE 4083 1BPN



BE 4068 1055



BE 4086 1055

Glass & Grille Options



6 Panel Grille



Clear



4 Panel Grille



Seedy



Single Panel



Frosted



Molding Options

Once you have your door style and color selected, it's time to add the finishing touches. Adding a crown molding to the top of your cabinets enhances the design of your cabinets.

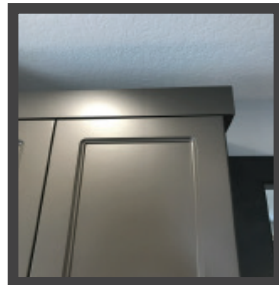
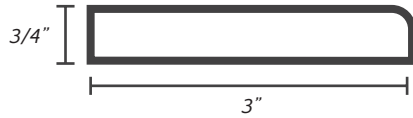

Flat R219

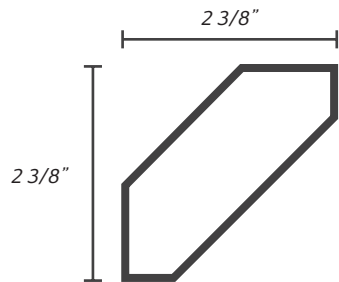

Shaker R161B

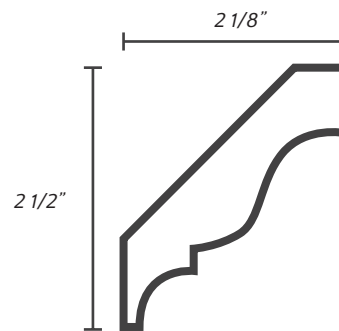

Traditional R113



Standard R176

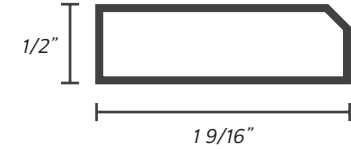

Quarter Round R124

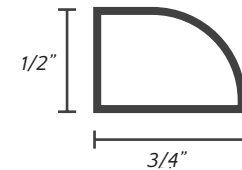

Square RT830

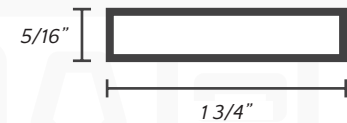

Adding a base shoe will give the base of your cabinets a finished look

Legs & Feet

While legs and feet serve a practical purpose of holding up a cabinet, it is most often chosen to add detail. Legs and Feet can also make an impact on the final design.

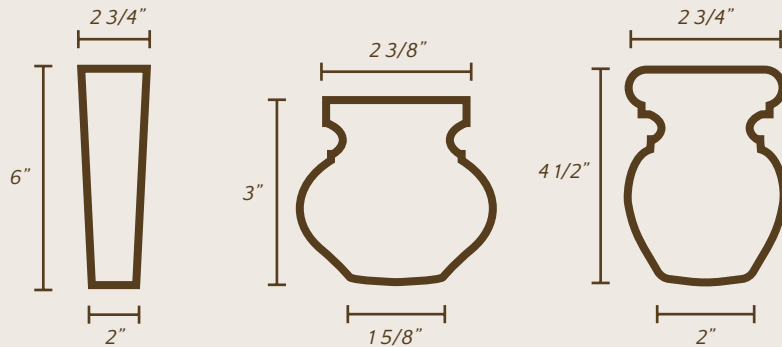

Two-Sided Taper Leg

*Medium Round
Bun Foot*

Apple Bun Foot

Island Posts



*6 x 6 Square
Flat Panel Post*



*3 x 3 Square
Post*

Corbels

Like legs and feet, with Corbels the key word here is support. Corbels are used to support countertops and shelving.

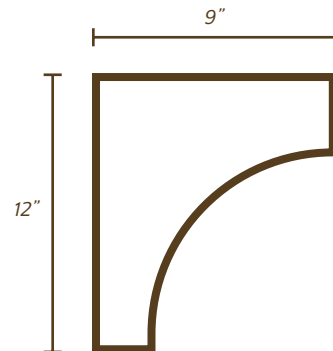



Wood Range Hoods



Signature, Straight



Signature Craftsmen, Arched

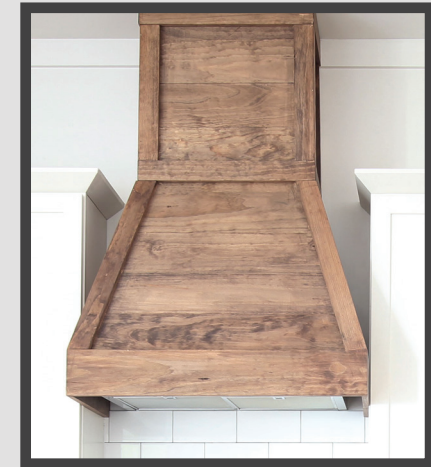

Modern Farmhouse, Tapered



Kitchen Storage
Solutions By

 **REV·A·SHELF**
Innovation through Organization™



Spice Rack



Wall Pull Out



Wood Super Susan



*Door Storage for
Cutting Boards*



Utensil Base Pullout



Mixer Lift Shelf



Cutting Board w/ Hole



Lazy Susan



Roll Out Trays



Base Pullout



Blind Corner Storage



Pots & Pans Hooks



Wood Cutlery Tray



Wood Knife Organizer



Tip Out Tray



Pots & Pans Organizer



Two Tier Cutlery Tray



Wood Utensil Organizer



Double Trash Pullout



Single Trash Pullout



Grooming Pullout #1



Grooming Pullout #2



Decorative Options



Square Flat Back Panel and/or Sides



Shiplap Back Panel and/or Sides



Floating Shelves



Wood Fireplace Surround (Insert Not Included)



Slab Mantle



Box Mantle

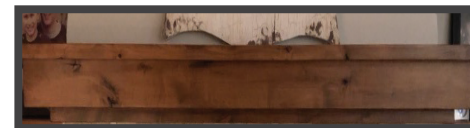

Tiered Mantle

Styles, product availability and construction may vary slightly from those shown in this book due to material availability and/or design evolution. Specifications are subject to change without notice. See your designer for details.

Product photography and illustrations have been reproduced as accurately as printing technologies permit. To ensure highest satisfaction, we strongly recommend you view an actual sample for best color, wood grain and finish representation.

SWI Interiors has a Limited Lifetime Warranty



www.swiinteriors.com
sales@swiinteriors.com
54485 State Hwy 34
Po Box 324
Osage, MN 56570
Ph: 218-573-3131
Toll Free: 800-573-0724